

# **BORDER COLLISION BIFURCATION: THEORY AND APPLICATIONS**

Soumitro Banerjee

*Department of Electrical Engineering  
Indian Institute of Technology  
Kharagpur — 721302, India*

In this talk we shall address the questions:

- What are border collision bifurcations?
- How to recognize them?
- In what kind of systems do they occur?
- How developed is the theory of border collision bifurcation?
- Can the theory be used for some useful purpose (design, control etc.)?

**Q1: What are the distinctive features of border collision bifurcations?**

The “textbook” structure of bifurcation diagram in smooth systems:

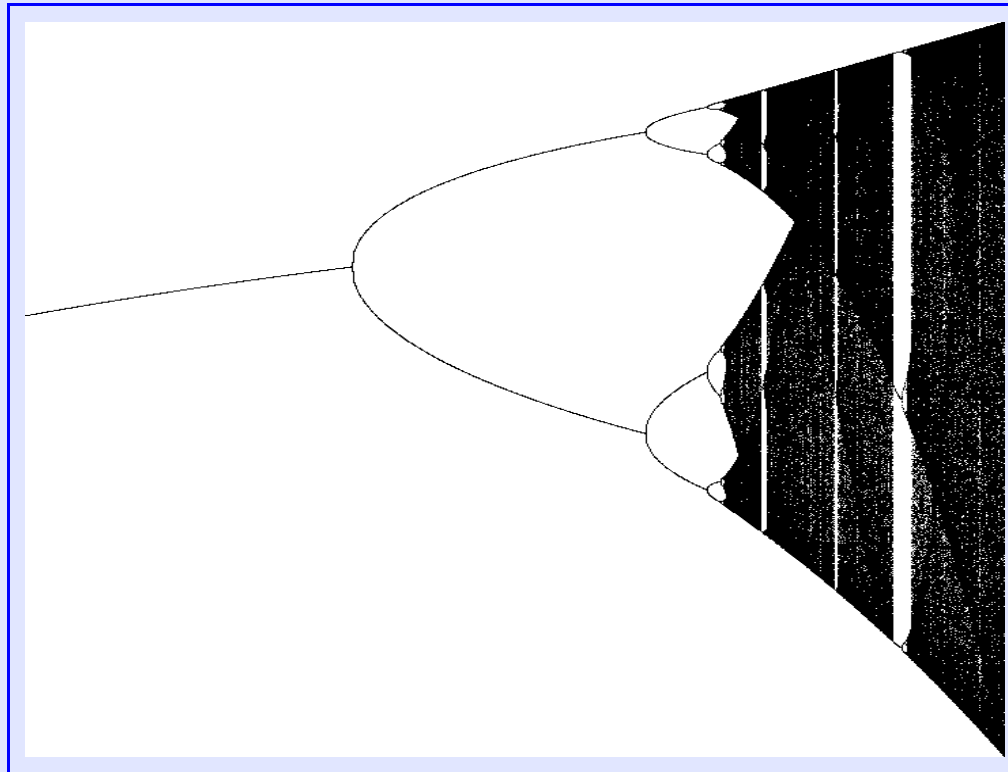

- Period doubling cascade
- Periodic windows within chaos

The nonstandard appearance of bifurcation diagrams in nonsmooth systems:

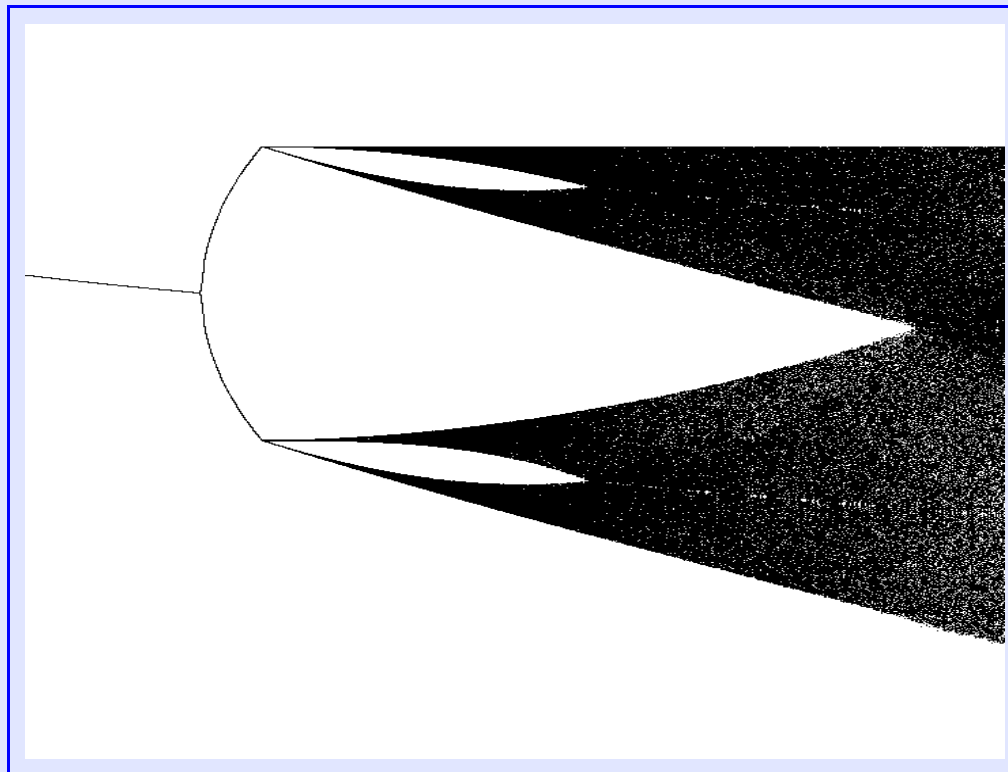

# More examples of “nonstandard” features:

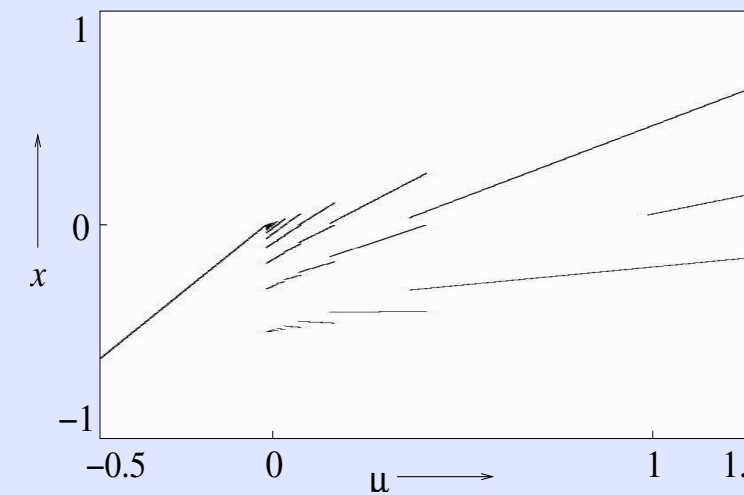
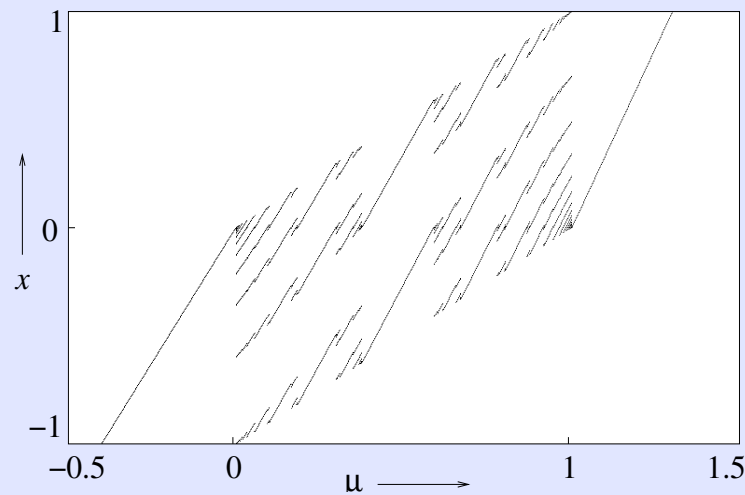
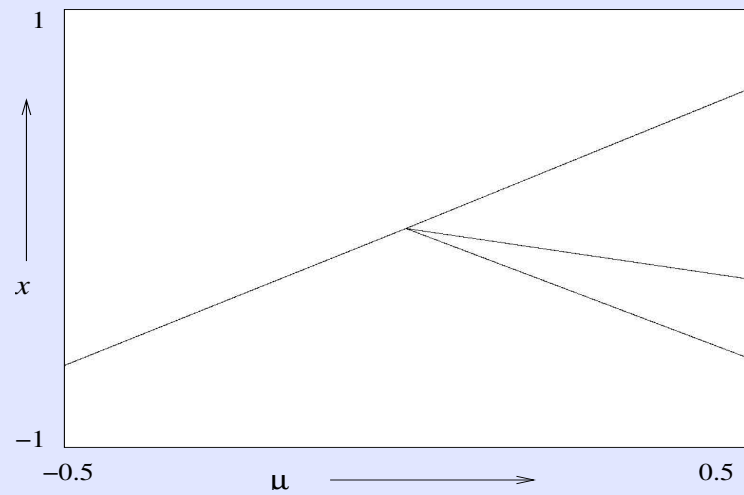
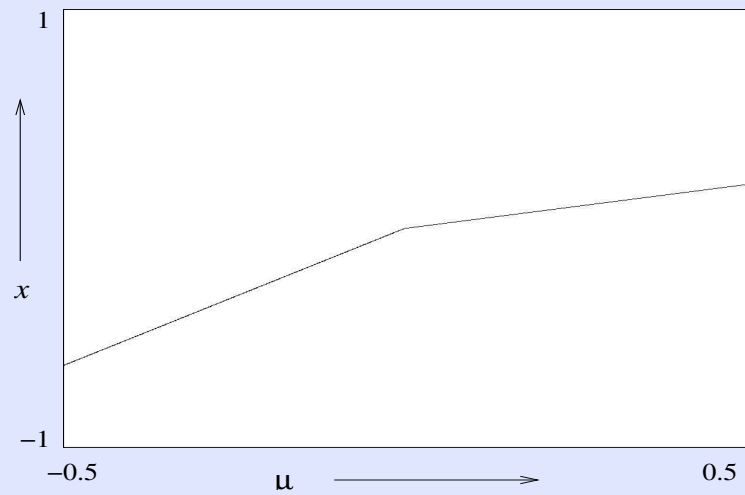

**Q2:** In what kind of systems do BCBs occur?

**Switching (or hybrid) systems** are dynamical systems with continuous-time evolution punctuated by discrete switching events.

In switching dynamical systems, discrete switching events occur when certain conditions on the state variables are satisfied. The discrete events signify some change in the continuous-time state variable equations.



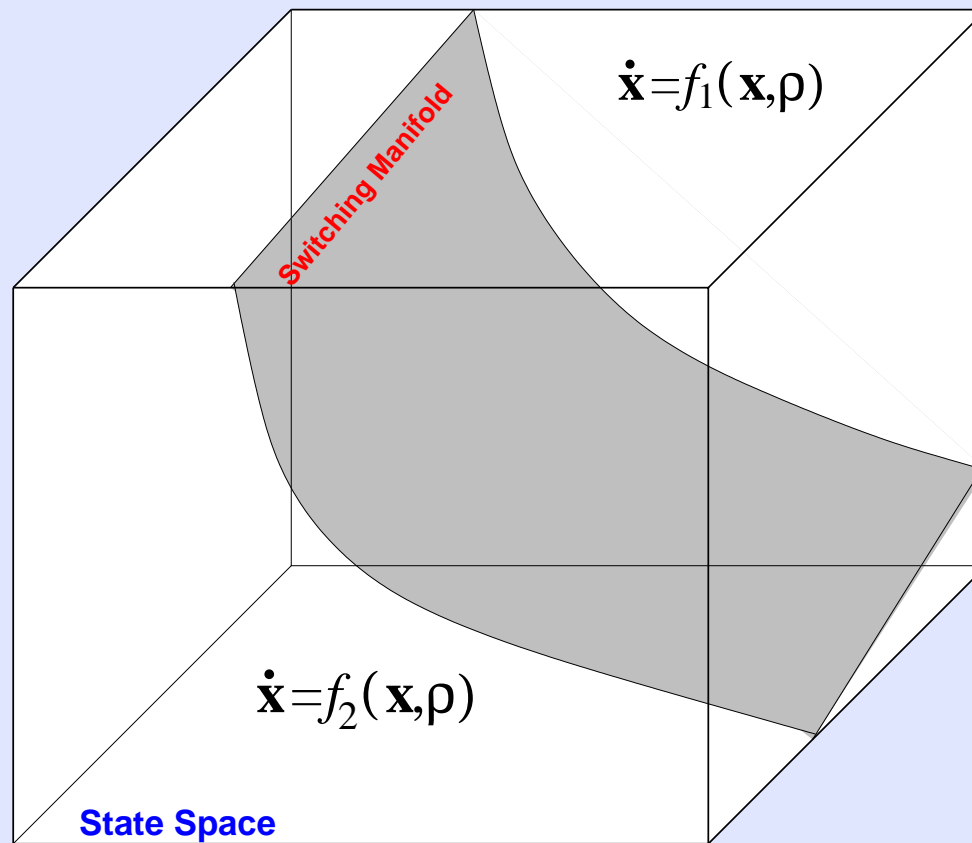

Schematic diagram showing the structure of the state space of a hybrid system.

Mathematically, these systems can be described by piecewise smooth vector fields

$$\dot{\mathbf{x}} = f(\mathbf{x}, \rho) = \begin{cases} f_1(\mathbf{x}, \rho) & \text{for } \mathbf{x} \in R_1 \\ f_2(\mathbf{x}, \rho) & \text{for } \mathbf{x} \in R_2 \\ \vdots & \\ f_n(\mathbf{x}, \rho) & \text{for } \mathbf{x} \in R_n \end{cases}$$

where  $R_1, R_2$  etc. are different regions of the state space, and  $\rho$  is a system parameter.

The regions are divided by the discrete event conditions. In the state space these are  $(n - 1)$  dimensional surfaces given by algebraic equations of the form

$$\Gamma_n(\mathbf{x}) = 0.$$

These are the “switching manifolds.”

There can also be systems where the state does not move between compartments in the state space, but switching events change the state equations:

$$\dot{\mathbf{x}} = f(\mathbf{x}, \rho) = \begin{cases} f_1(\mathbf{x}, \rho) & \text{for } \Gamma_1(\mathbf{x}) = 0 \\ f_2(\mathbf{x}, \rho) & \text{for } \Gamma_2(\mathbf{x}) = 0 \\ \vdots & \\ f_n(\mathbf{x}, \rho) & \text{for } \Gamma_n(\mathbf{x}) = 0 \end{cases}$$

where  $\Gamma_1(\mathbf{x})$ ,  $\Gamma_2(\mathbf{x})$  etc. are switching conditions.

There can also be systems where the state equations do not change, but the state variable jumps to a different value as a switching condition is satisfied.

$$\dot{\mathbf{x}} = f(\mathbf{x}, \rho)$$

and if  $\mathbf{x} \in B : \Gamma(\mathbf{x}) = 0$ , then  $\mathbf{x} \mapsto \mathbf{x}'$ .

## Examples:

- Power electronic circuits
- Systems involving relays
- Impacting mechanical systems
- Systems involving dry friction (stick-slip motion)
- Nonlinear circuits like the Colpitt's oscillator, Chua's circuit etc.
- Walking robots
- Hydraulic systems with on-off valves, the human heart
- Continuous systems controlled by discrete logic.

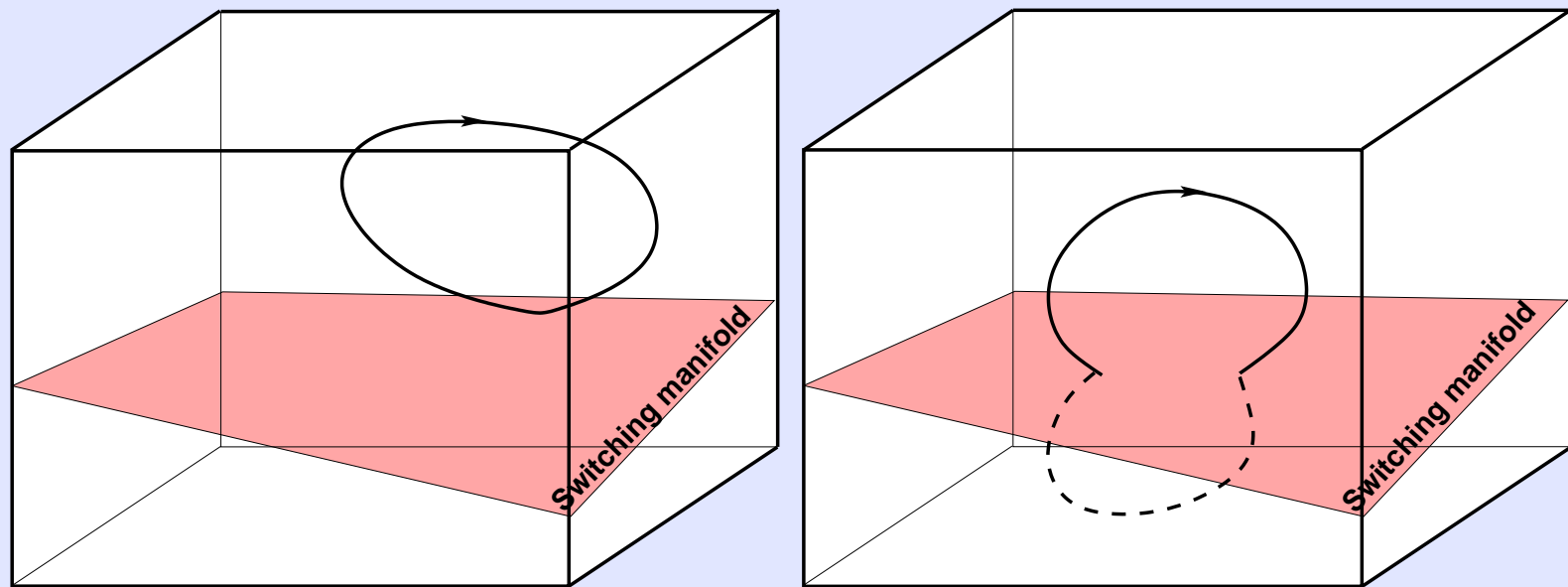

In case of hybrid systems there can be two (or more) different types of orbits depending on which regions in the state space are visited.

Therefore the Poincaré section must yield different functional forms of the map depending on the number of crossing of the switching manifold.

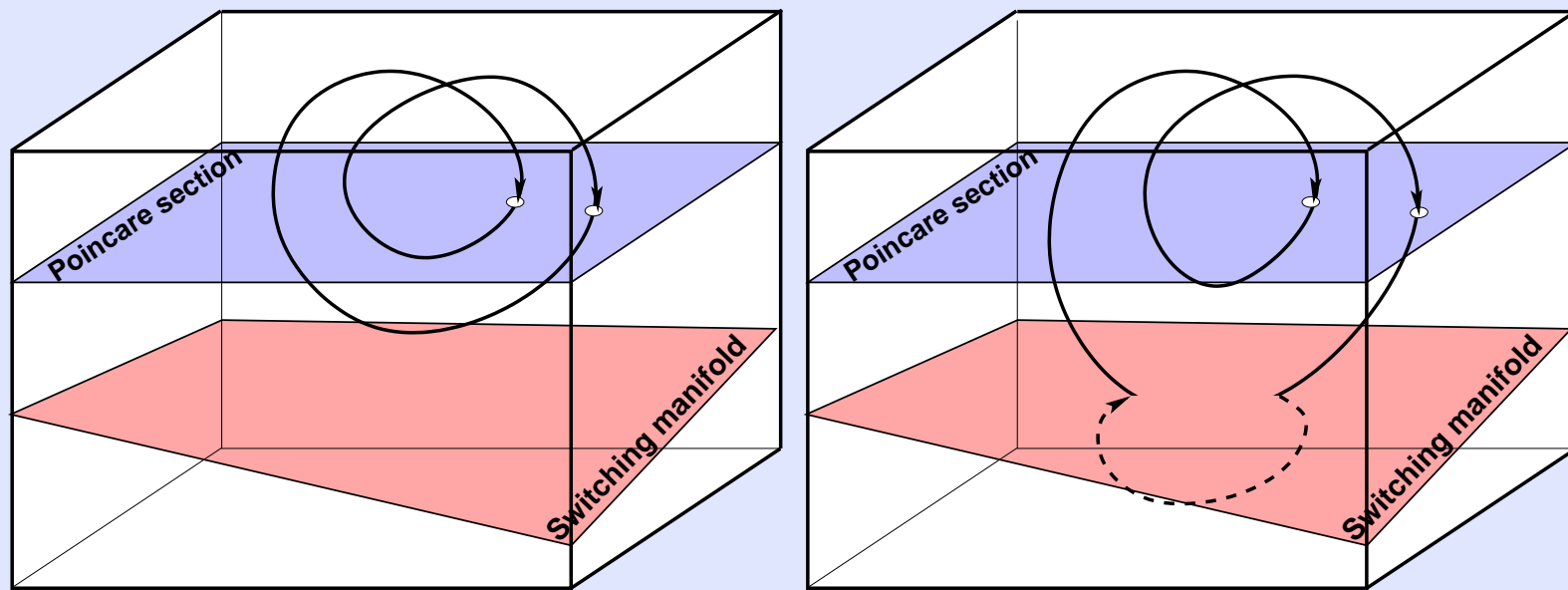



This implies that the structure of the discrete state space for a hybrid system must be piecewise smooth (PWS).

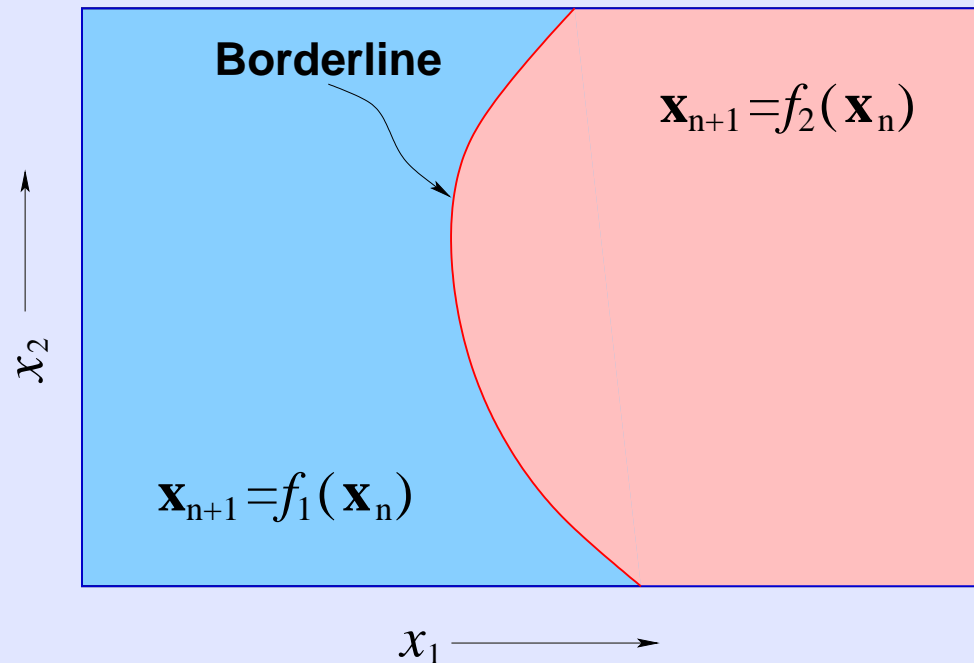

The borderline in discrete domain corresponds to the condition where the orbit grazes the switching manifold in the continuous-time system.

## Dynamics of Piecewise Smooth Maps

- If a fixed point loses stability while in either side, the resulting bifurcations can be categorized under the generic classes for smooth bifurcations.
- But what if a fixed point crosses the borderline as some parameter is varied?

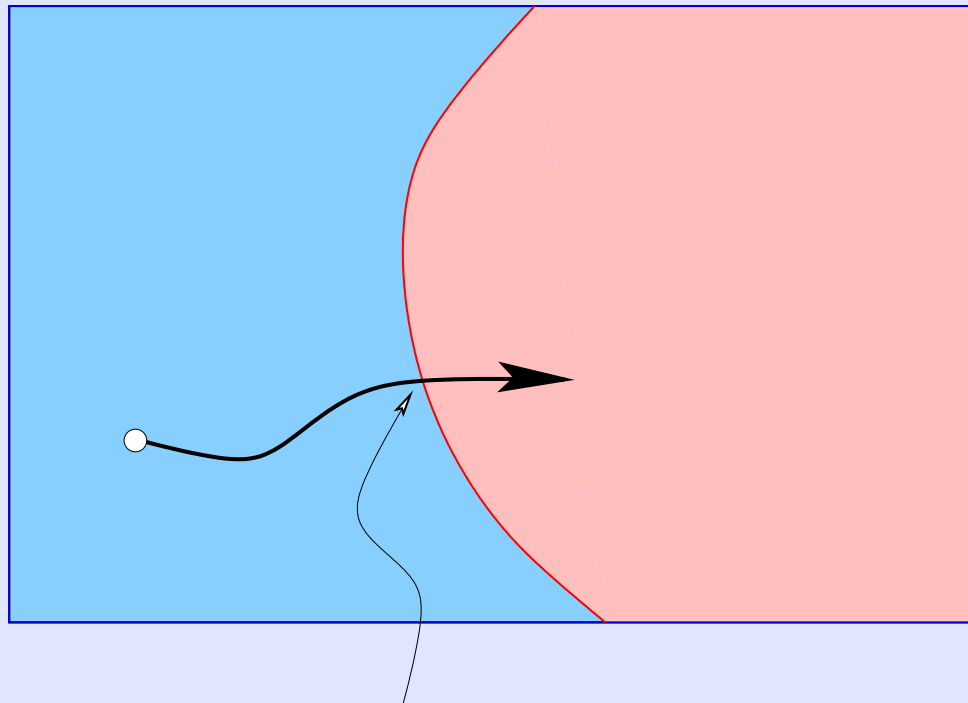

**The Jacobian elements discretely  
change at this point**

- The eigenvalues may jump from any value to any other value across the unit circle.
- The resulting bifurcations are called *Border Collision Bifurcations*.

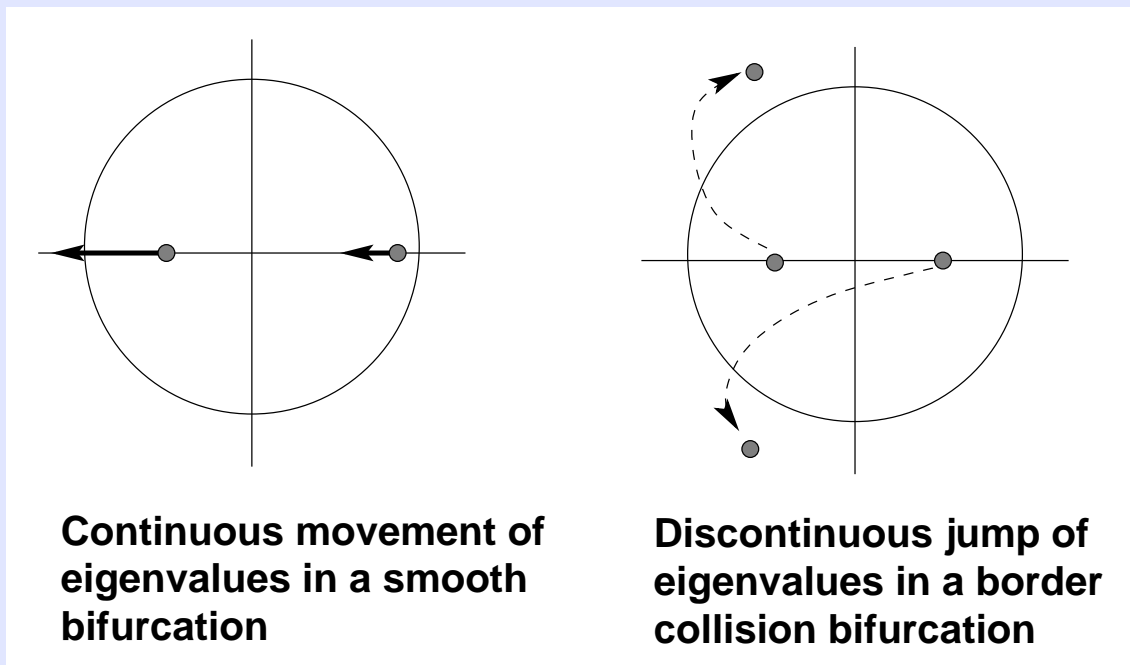

Therefore,

- In switching dynamical systems the bifurcation sequence is governed by a complex interplay between smooth bifurcations and border collision bifurcations.
- The different types of smooth bifurcations are well known. What are the different types of BCBs?
- The answer to this question depends on the character of the borderline and that of the functions at the two sides of the border.

**Q3: What are the different types of 1-D piecewise smooth maps?**

## 1. Map continuous, derivative discontinuous but finite.

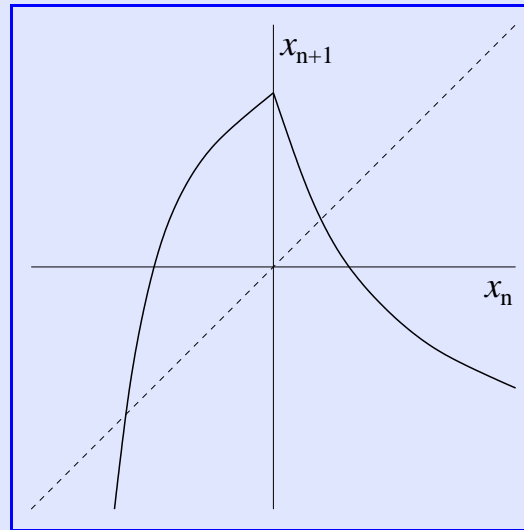

1. H. E. Nusse and J. A. Yorke, “Border-collision bifurcations for piecewise smooth one dimensional maps,” *International Journal of Bifurcation and Chaos*, vol. 5, no. 1, pp. 189–207, 1995.
2. S. Banerjee, M. S. Karthik, G. H. Yuan, and J. A. Yorke, “Bifurcations in one-dimensional piecewise smooth maps — theory and applications in switching circuits,” *IEEE Transactions on Circuits and Systems-I*, vol. 47, no. 3, 2000.

## The current mode controlled buck converter

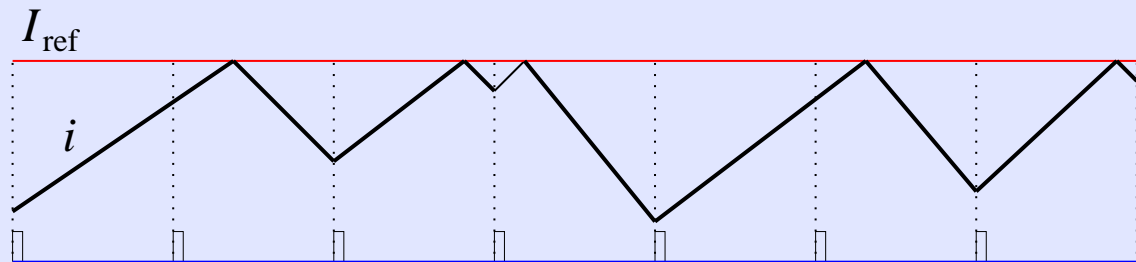
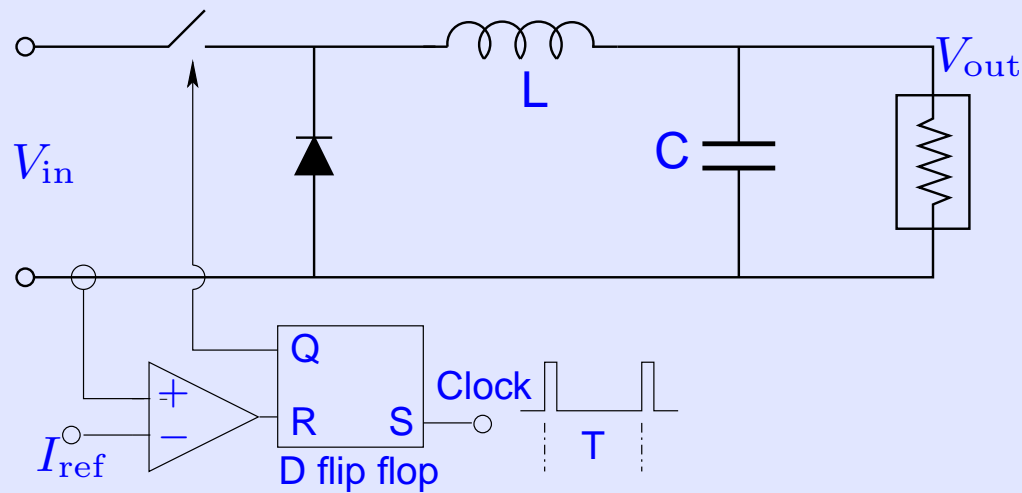



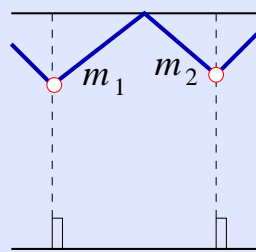

**Case 1**

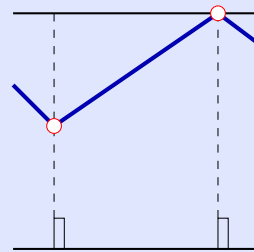

**Borderline case**

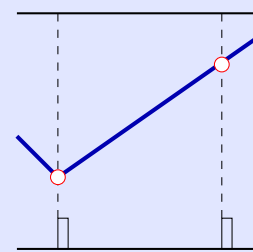

**Case 2**

$$m_1 = \frac{V_{in} - v_{out}}{L}$$

$$m_2 = \frac{v_{out}}{L}$$

Case 1:  $i_{n+1} = f_1(i_n) = i_n + m_1 T$

Borderline:  $I_b = I_{ref} - m_1 T$

Case 2:  $i_{n+1} = f_2(i_n) = \left(1 + \frac{m_2}{m_1}\right) I_{ref} - m_2 T - \frac{m_2}{m_1} i_n$

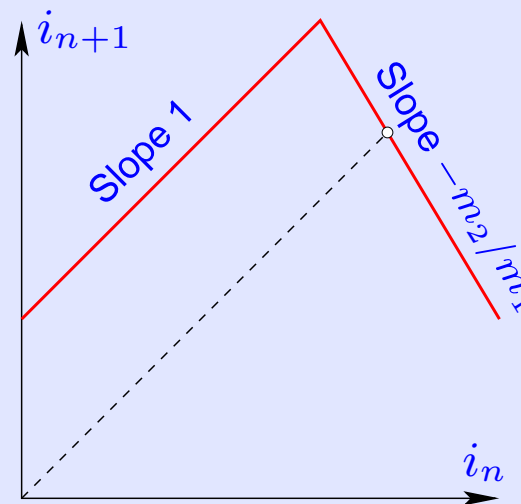

## Example 2: Internet packet transfer using TCP-RED

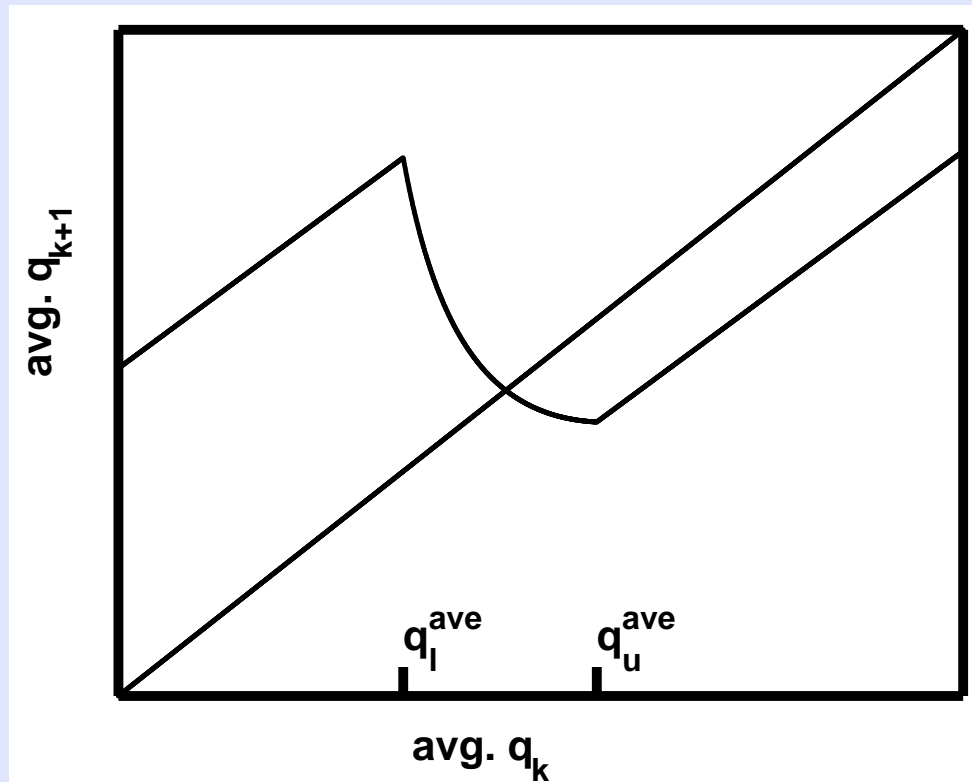

The graph of the map

## 2. Map and the derivative both discontinuous, but finite

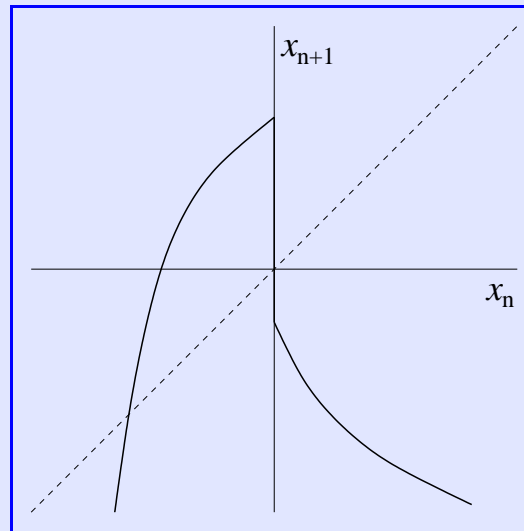

1. P. Jain and S. Banerjee, "Border collision bifurcations in one-dimensional discontinuous maps." IJBC, Vol. 13, No. 11, 2003, pp.3341-3352.

## Example: The Sigma-Delta modulator

$$x_{n+1} = px_n + s - \text{sign}(x_n).$$

Here  $s \in [-1, 1]$  is the input signal of the circuit (a parameter),  $x$  represents the output of the circuit, and  $p > 0$  is a non-ideality parameter.

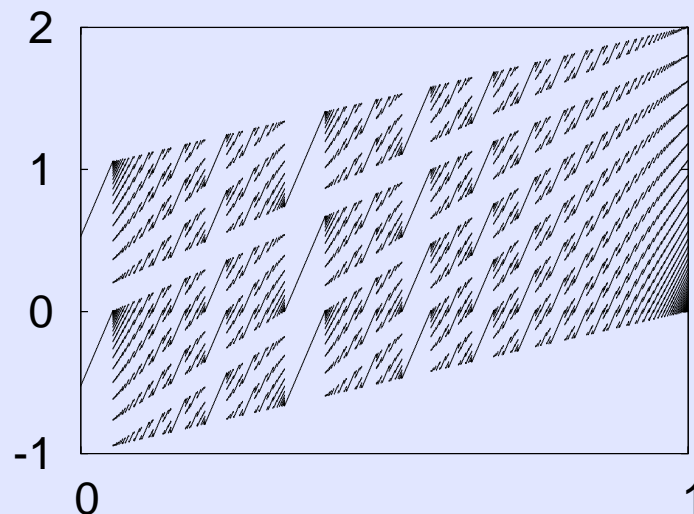

3. Map continuous but has square-root singularity; derivative discontinuous.

Example:

$$F_{\mu}(x) = \begin{cases} \alpha x + \mu & \text{if } x \leq 0 \\ \beta\sqrt{x} + \mu & \text{if } x \geq 0 \end{cases}$$

where  $0 < \alpha < 1$  and  $\beta < -1$ .

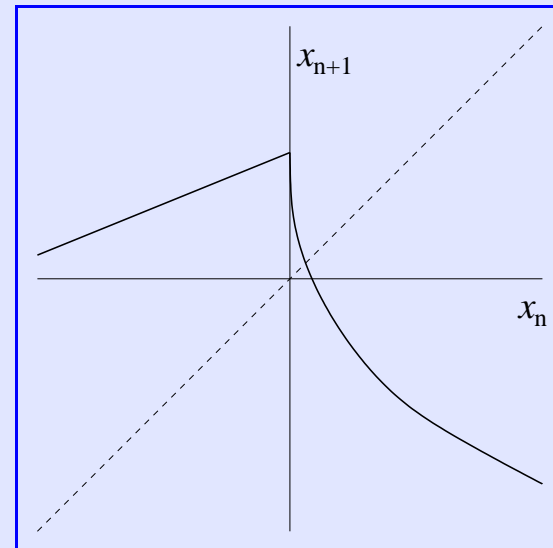

It represents the impact oscillator. Extensive investigation has been reported.

4. Map discontinuous, and has square-root singularity

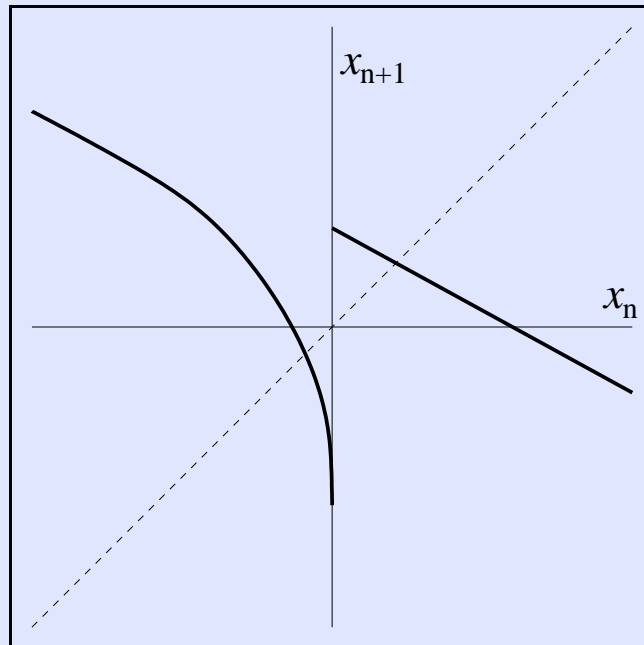

Theory not yet developed.

## Example : The Colpitt's Oscillator

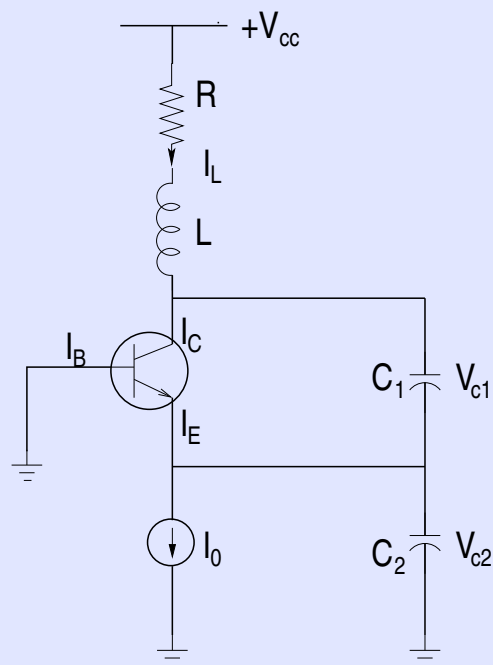

G. M. Maggio, M. di Bernardo and M. P. Kennedy, "Nonsmooth Bifurcations in a Piecewise-Linear Model of the Colpitts Oscillator", IEEE Trans. CAS-I, **47**, 2000.

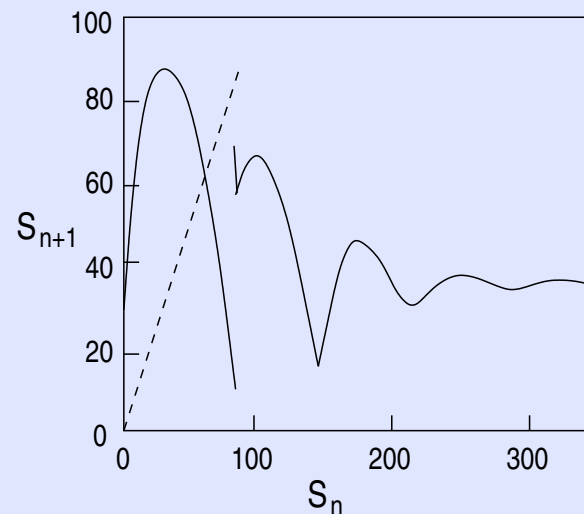

## 5. Map with singularity at borderline — both in magnitude and slope

$$x_{n+1} = \gamma x_n + \frac{\alpha x_n}{(x_n - \lambda)^2} \quad \text{for } x_n < \lambda$$
$$x_{n+1} = \beta + \frac{\rho x_n}{(x_n - \lambda)^2} \quad \text{for } x_n > \lambda$$

1. W. Tao Shi, Christopher L. Gooderidge, and Daniel P. Lathrop, *Breaking waves: bifurcations leading to a singular state*, *Physical Review E* **56** (1997), 4157–4161.
2. Alope Kumar and Soumitro Banerjee, “Dynamics of a piecewise smooth map with singularity,” *Physics Letters A*, Vol. 337/1-2, 2005, pp. 87-92.

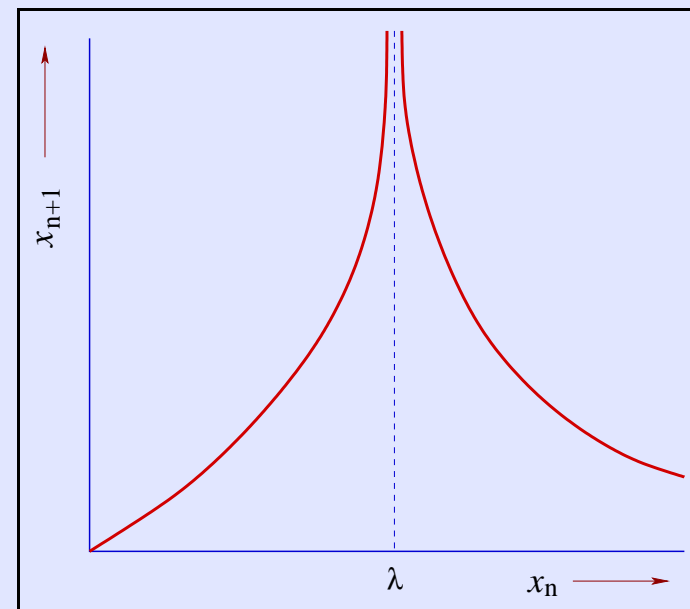



Likewise in 2-D systems, the classification will depend on the continuity of the function across the border and the Jacobian elements at the two sides of the border.

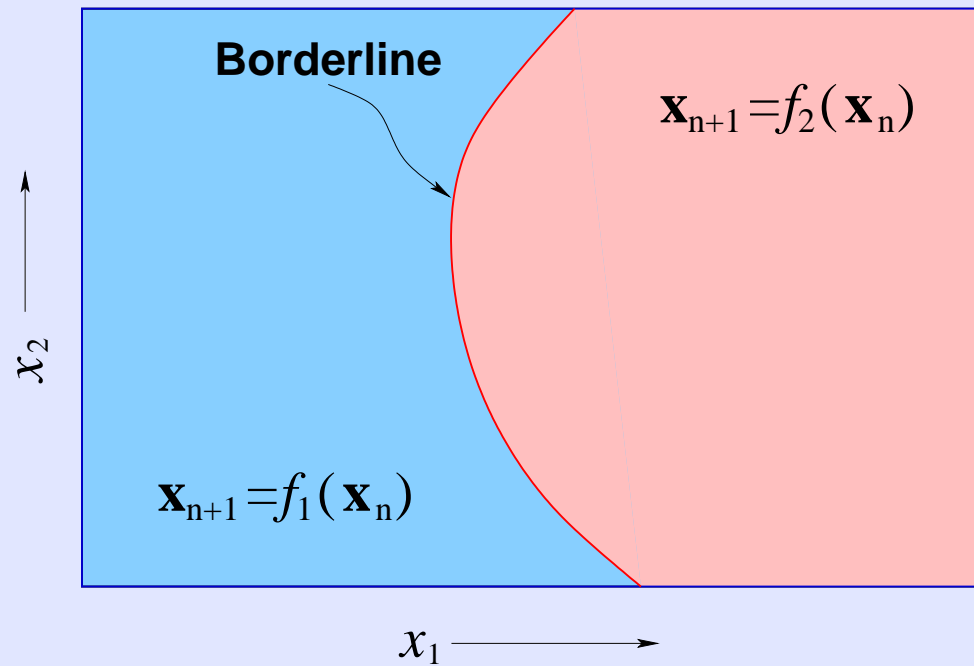

There are the following possibilities:

**System type 1:** The function is continuous, but Jacobian changes discontinuously across borderline.

1. S. Banerjee, C. Grebogi, “Border Collision Bifurcations in Two-Dimensional Piecewise Smooth Maps”, *Physical Review E*, Vol.59, No.4, 1 April, 1999, pp.4052-4061.
2. S. Banerjee, P. Ranjan and C. Grebogi, “Bifurcations in two-dimensional piecewise smooth maps — theory and applications in switching circuits”, *IEEE Trans. Circuits & Systems–I*, vol.47, no. 5, pp.633-643, 2000.

**Q4:** How can we analyse the bifurcation in such a system?

## Basic tool: The normal form

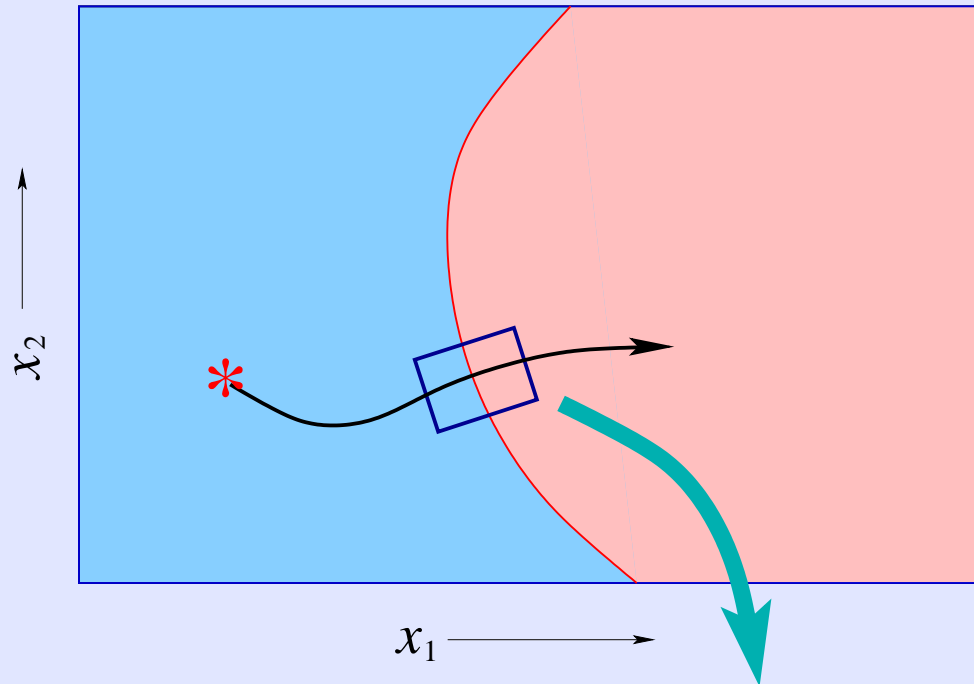

$$\begin{pmatrix} x_{n+1} \\ y_{n+1} \end{pmatrix} = \begin{pmatrix} \tau_L & 1 \\ -\delta_L & 0 \end{pmatrix} \begin{pmatrix} x_n \\ y_n \end{pmatrix} + \mu \begin{pmatrix} 1 \\ 0 \end{pmatrix} \quad \text{for } x_n \leq 0$$

$$\begin{pmatrix} x_{n+1} \\ y_{n+1} \end{pmatrix} = \begin{pmatrix} \tau_R & 1 \\ -\delta_R & 0 \end{pmatrix} \begin{pmatrix} x_n \\ y_n \end{pmatrix} + \mu \begin{pmatrix} 1 \\ 0 \end{pmatrix} \quad \text{for } x_n > 0$$

Any system of the form

$$\begin{pmatrix} \bar{x}_{k+1} \\ \bar{y}_{k+1} \end{pmatrix} = \underbrace{\begin{pmatrix} a_1 & a_2 \\ a_3 & a_4 \end{pmatrix}}_A \begin{pmatrix} \bar{x}_k \\ \bar{y}_k \end{pmatrix} + \begin{pmatrix} 1 \\ 0 \end{pmatrix} \mu$$

with  $a_3 \neq 0$  can be transformed to the 2-D normal form

$$\begin{pmatrix} x_{k+1} \\ y_{k+1} \end{pmatrix} = \begin{pmatrix} \tau & 1 \\ -\delta & 0 \end{pmatrix} \begin{pmatrix} x_k \\ y_k \end{pmatrix} + \begin{pmatrix} 1 \\ 0 \end{pmatrix} \mu$$

using the transformation

$$x_k = T \bar{x}_k \quad \text{and} \quad T = \begin{pmatrix} 1 & \frac{a_4}{a_3} \\ 0 & -\frac{\delta}{a_3} \end{pmatrix}$$

where  $\tau := \text{trace}(A) = a_1 + a_4$  and  $\delta := \det(A) = a_1 a_4 - a_2 a_3$ .

## Classification of border collision bifurcations

To work out the asymptotically stable orbits depending on which type of fixed point collides with the border and turns into which other type, and to partition the parameter space into regions of the same type of asymptotic behavior. <sup>a</sup>

---

<sup>a</sup>Banerjee, Yorke and Grebogi, PRL, **80**, 1998;  
Banerjee and Grebogi, PRE, **59**, 1999;  
Banerjee, Karthik, Yuan and Yorke, IEEE CAS-I, **47**, 2000;  
Banerjee, Ranjan and Grebogi, IEEE CAS-I, **47**, 2000

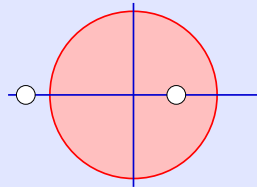

**The fixed point is a flip saddle if**  
 $\tau < -(1+\delta)$

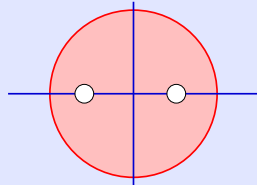

**The fixed point is a flip attractor if**  
 $-(1+\delta) < \tau < -2\sqrt{\delta}$

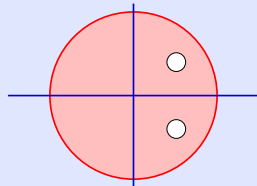

**The fixed point is a spiral attractor if**  
 $-2\sqrt{\delta} < \tau < 2\sqrt{\delta}$

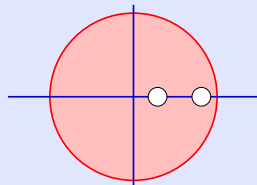

**The fixed point is a regular attractor if**  
 $2\sqrt{\delta} < \tau < (1+\delta)$

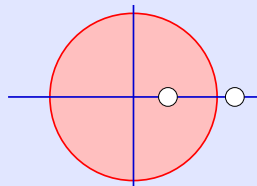

**The fixed point is a regular saddle if**  
 $\tau > (1+\delta)$

## The possible types of fixed points of the normal form map.

Type	eigenvalues	condition	identifiers
<b>For positive determinant</b>			
Regular attractor	real, $0 < \lambda_1, \lambda_2 < 1$	$2\sqrt{\delta} < \tau < (1 + \delta)$	$\sigma^+ = 0, \sigma^- = 0$
Regular saddle	real, $0 < \lambda_1 < 1, \lambda_2 > 1$	$\tau > (1 + \delta)$	$\sigma^+ = 1, \sigma^- = 0$
Flip attractor	real, $0 > (\lambda_1, \lambda_2) > -1$	$-2\sqrt{\delta} > \tau > -(1 + \delta)$	$\sigma^+ = 0, \sigma^- = 0$
Flip saddle	real, $0 < \lambda_1 < 1, \lambda_2 < -1$	$\tau < -(1 + \delta)$	$\sigma^+ = 0, \sigma^- = 1$
Spiral attractor	complex, $ \lambda_1 ,  \lambda_2  < 1$		
(a) Clockwise spiral		$0 < \tau < 2\sqrt{\delta}$	$\sigma^+ = 0, \sigma^- = 0$
(b) Counter-clockwise spiral		$-2\sqrt{\delta} < \tau < 0$	$\sigma^+ = 0, \sigma^- = 0$
<b>For negative determinant</b>			
Flip attractor	$0 > \lambda_1 > -1, 1 > \lambda_2 > 0$	$-(1 + \delta) < \tau < (1 + \delta)$	$\sigma^+ = 0, \sigma^- = 0$
Flip saddle	$\lambda_1 > 1, -1 < \lambda_2 < 0$	$\tau > 1 + \delta$	$\sigma^+ = 1, \sigma^- = 0$
Flip saddle	$0 < \lambda_1 < 1, \lambda_2 < -1$	$\tau < -(1 + \delta)$	$\sigma^+ = 0, \sigma^- = 1$



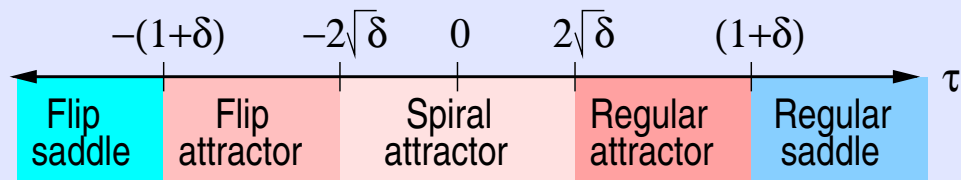

Each box in this parameter space partitioning means a specific type of fixed point changes to another specific type.

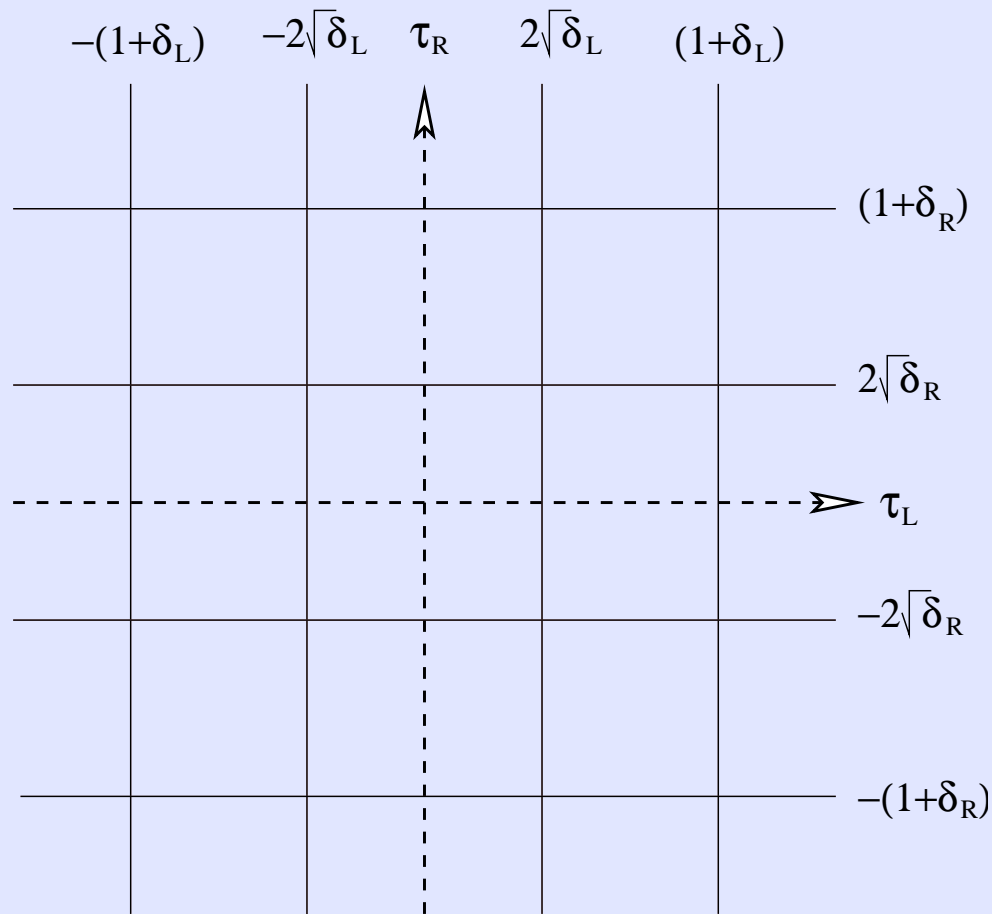

## Primary partitioning

Depending on the types of fixed point at the two sides of the border, there can be three basic types of BCBs.

1. **Scenario A:** Persistent fixed point
2. **Scenario B:** Border collision pair bifurcation
3. **Scenario C:** Border crossing bifurcation.

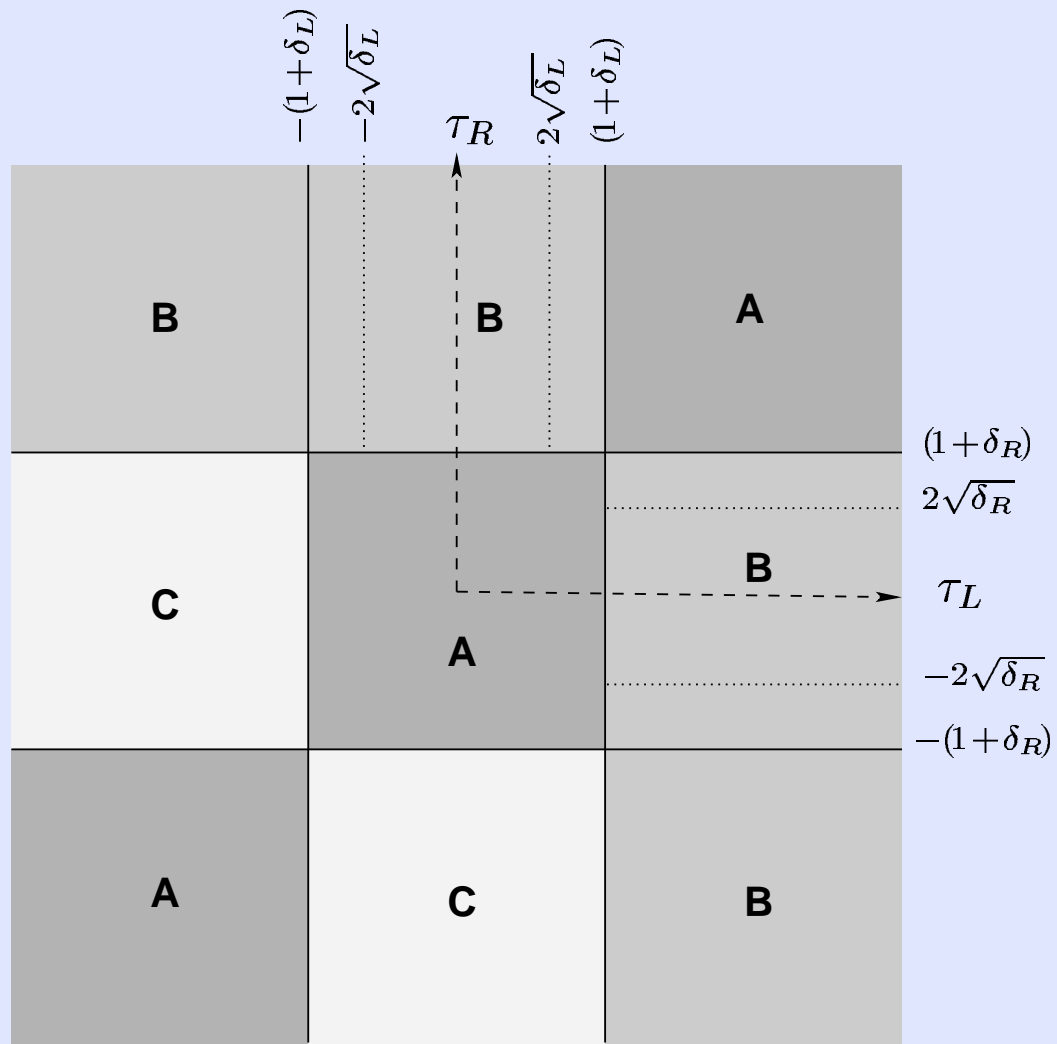

It was found that the asymptotic behavior is not the same throughout each partition. Need was felt to make a “secondary partitioning.”

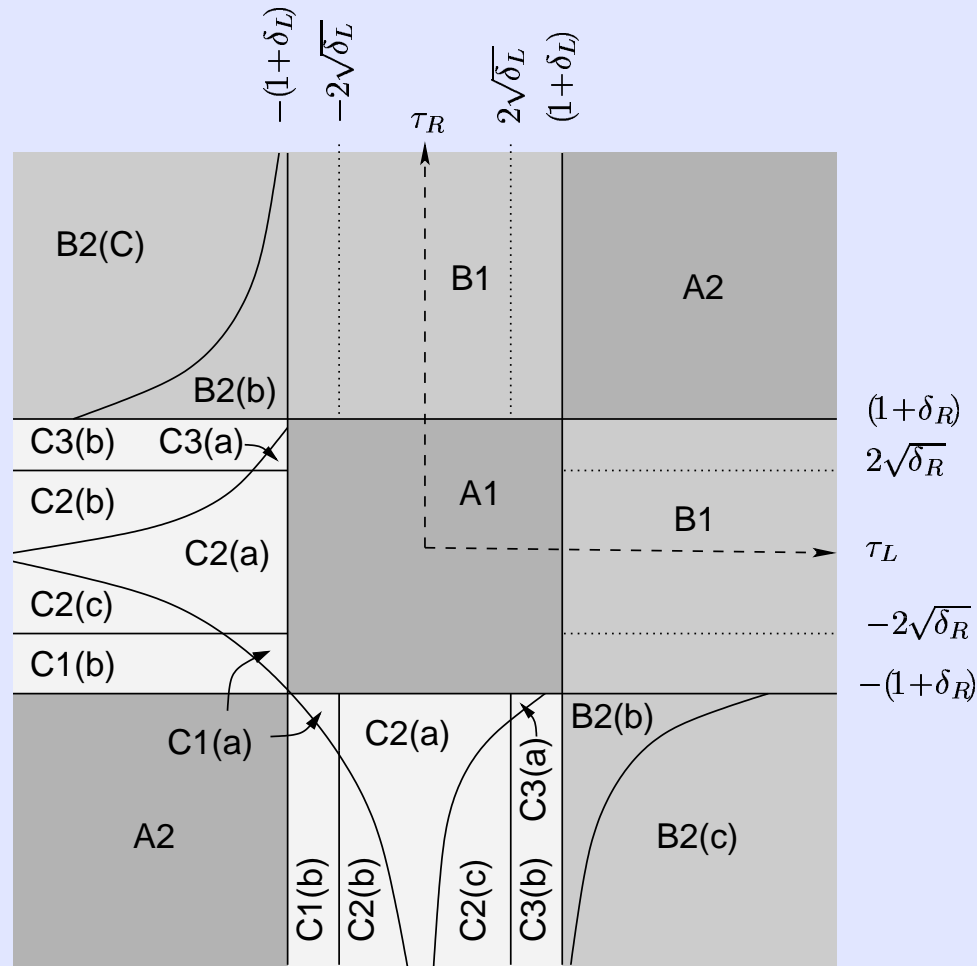

## Scenario A1: A fixed point remains stable. But ...

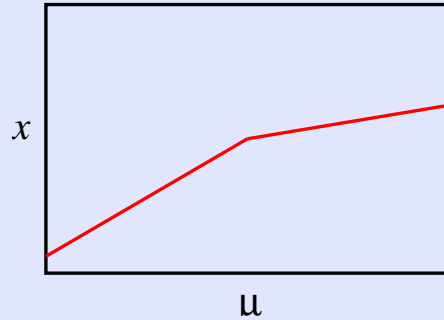

The “normal” case.

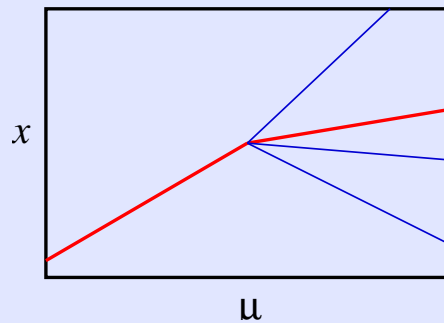

M. Dutta, H. E. Nusse, E. Ott, J. A. Yorke and G-H. Yuan,  
PRL, **83**, 1999.

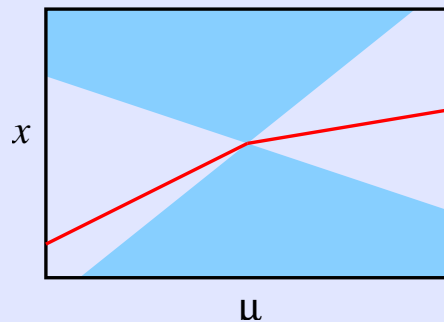

Anindita Ganguli and Soumitro Banerjee, “Dangerous bi-  
furcation at border collision — when does it occur?” *PRE*,  
Vol.71, No.5, 2005.

# Scenario B: A pair of fixed points are born. But ...

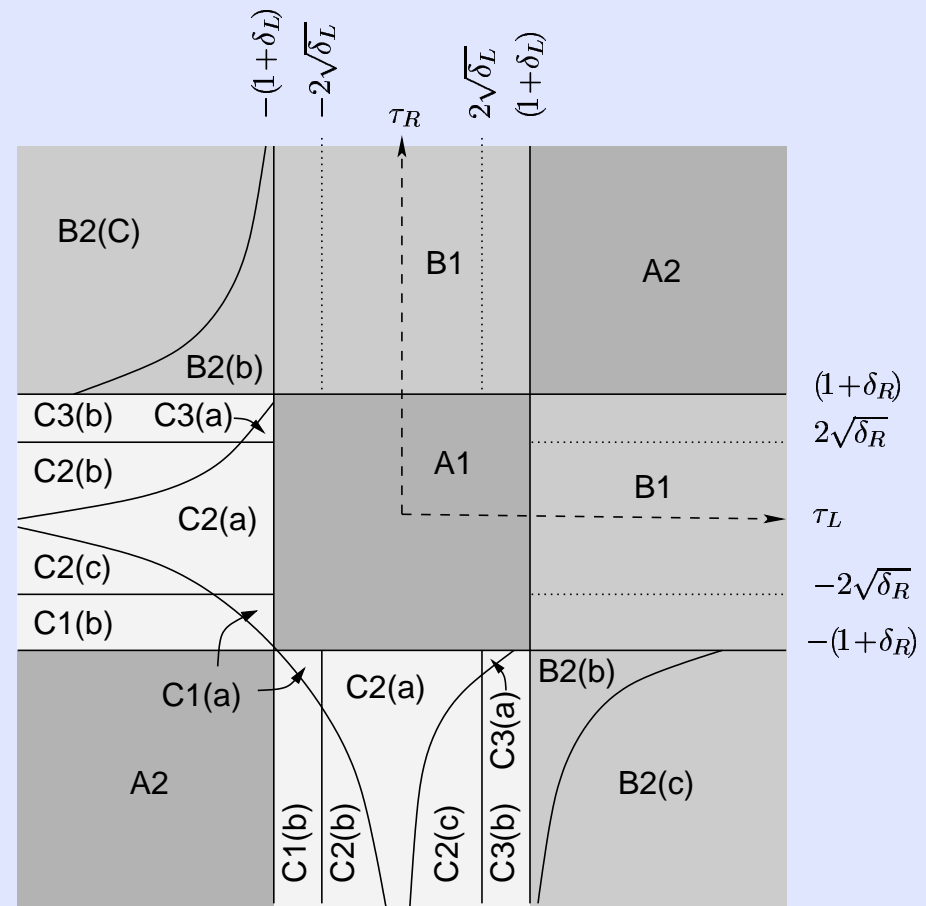
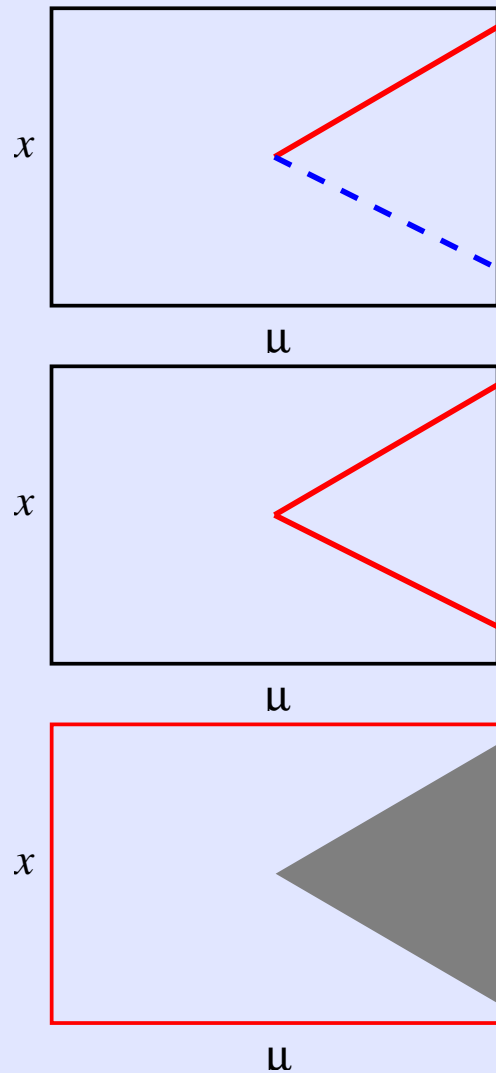

**Scenario C:** A fixed point loses stability as it moves across the border.

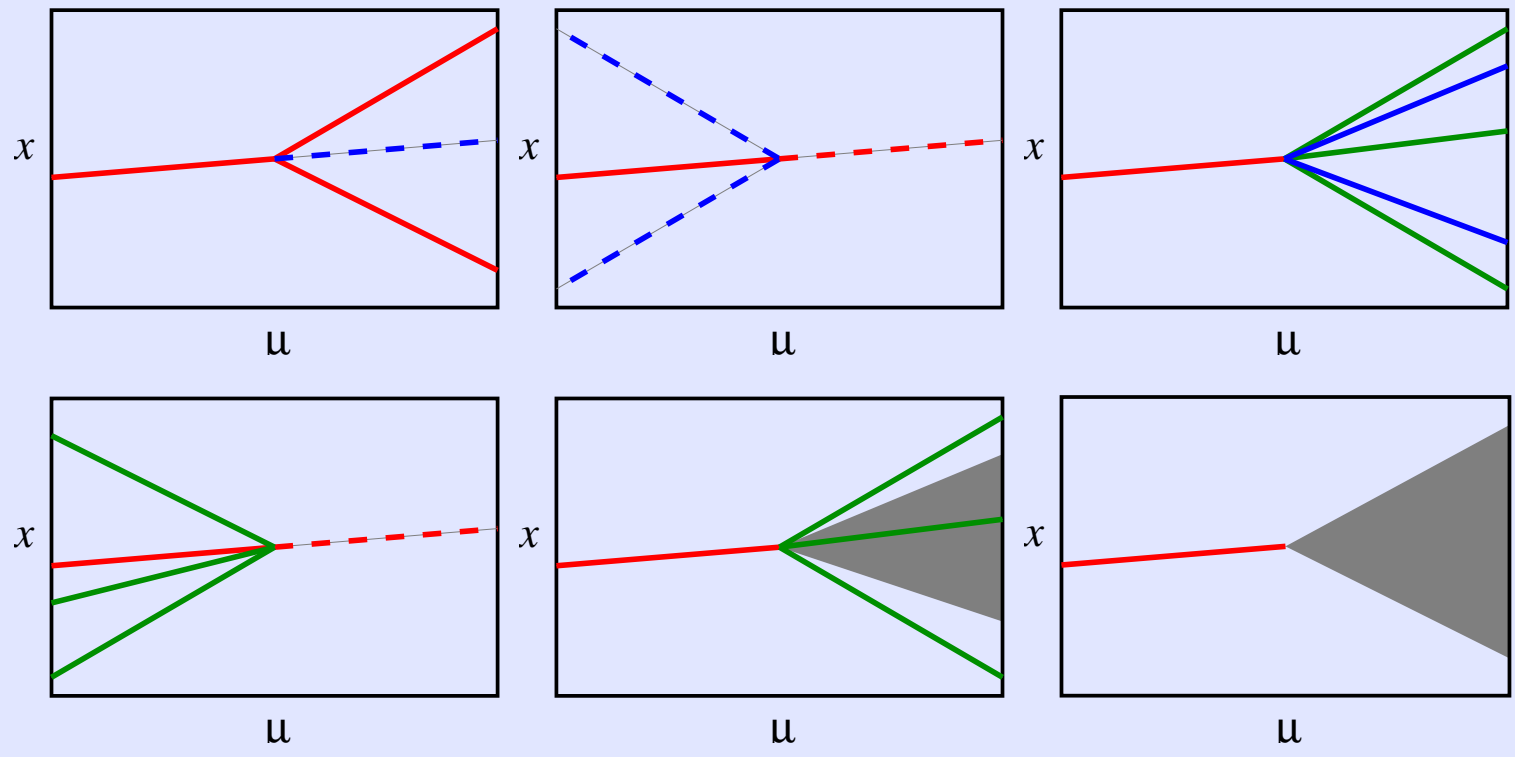

**2D System type 2:** Determinant greater than unity in one side of borderline (fixed point can be repeller). Birth of a torus through border collision bifurcation.

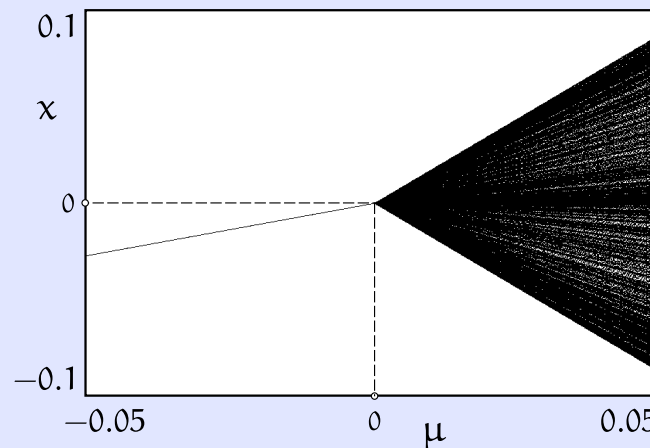
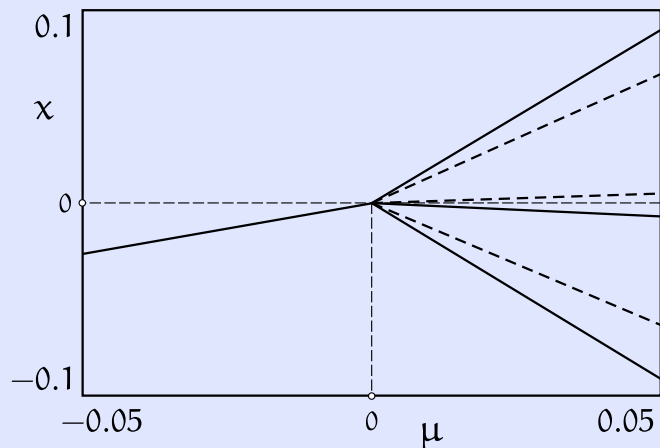

Z. T. Zhusubaliyev, E. Mosekilde, S. Maiti, S. Mohanan and S. Banerjee “The Border-Collision Route to Quasiperiodicity: Numerical Investigation and Experimental Confirmation,” *Chaos*, Sept. 2006.



2D System type 3: The function as well as the Jacobian are discontinuous across the borderline.

*Work in progress.*

## 2D System type 4: Maps with square root singularity.

*For mechanical systems undergoing soft impacts, it has been shown that the determinant remains constant but the trace of the Jacobian shows a square-root singularity.*

Yue Ma, Manish Agarwal, and Soumitro Banerjee, "Border Collision Bifurcations in a Soft Impact System," *Physics Letters A*, Vol. 354, No.4, 2006, pp. 281-287.

**2D System type 5:** System dimension different at the two sides of a borderline.

Sukanya Parui and Soumitro Banerjee, "Border Collision Bifurcation at the Change of State-Space Dimension", *Chaos*, Vol. 12, No.4, pp. 1160-1177, 2002.

**Q5: Is there any tool to analyse the bifurcations in systems of dimension 3 or higher?**

**Feigin's approach:** Classify the BCBs according to the existence and stability of period-1 and period-2 fixed points.

M. di Bernardo, M. I. Feigin, S. J. Hogan, M. E. Homer, "Local analysis of  $C$ -bifurcations in  $n$ -dimensional piecewise smooth dynamical systems", "Chaos, Solitons & Fractals", Vol.10, No.11, pp. 1881-1908, 1999.

Step 1: define the following identifiers:

$$\sigma_L^+ := \text{number of real eigenvalues of } \mathbf{J}_L > +1$$

$$= \begin{cases} 1 & \text{if } \tau_L > (1 + \delta_L) \\ 0 & \text{if } \tau_L < (1 + \delta_L) \end{cases}$$

$$\sigma_L^- := \text{number of real eigenvalues of } \mathbf{J}_L < -1$$

$$= \begin{cases} 1 & \text{if } \tau_L < -(1 + \delta_L) \\ 0 & \text{if } \tau_L > -(1 + \delta_L) \end{cases}$$

$$\sigma_R^+ := \text{number of real eigenvalues of } \mathbf{J}_R > +1$$

$$= \begin{cases} 1 & \text{if } \tau_R > (1 + \delta_R) \\ 0 & \text{if } \tau_R < (1 + \delta_R) \end{cases}$$

$$\sigma_R^- := \text{number of real eigenvalues of } \mathbf{J}_R < -1$$

$$= \begin{cases} 1 & \text{if } \tau_R < -(1 + \delta_R) \\ 0 & \text{if } \tau_R > -(1 + \delta_R) \end{cases}$$

$$\sigma_{LL}^+ := \text{number of real eigenvalues of } \mathbf{J}_L \mathbf{J}_L > +1$$

$$= \begin{cases} 1 & \text{if } \tau_L > (1 + \delta_L) \\ 0 & \text{if } \tau_L < (1 + \delta_L) \end{cases}$$

$$\sigma_{LR}^+ := \text{number of real eigenvalues of } \mathbf{J}_L \mathbf{J}_R > +1$$

$$= \begin{cases} 1 & \text{if } \tau_L \tau_R > (1 + \delta_L)(1 + \delta_R) \\ 0 & \text{if } \tau_L \tau_R < (1 + \delta_L)(1 + \delta_R) \end{cases}$$

$$\sigma_{LR}^- := \text{number of real eigenvalues of } \mathbf{J}_L \mathbf{J}_R < -1$$

$$= \begin{cases} 1 & \text{if } \tau_R \tau_L < -(1 - \delta_R)(1 - \delta_L) \\ 0 & \text{if } \tau_R \tau_L > -(1 - \delta_R)(1 - \delta_L) \end{cases}$$

## Step 2: The basic classification

If  $\sigma_L^+ + \sigma_R^+$  is even,  
then there is a smooth transition of one orbit to another at a  
border collision.

If  $\sigma_L^+ + \sigma_R^+$  is odd,  
then two orbits merge and disappear at the border.

If  $\sigma_L^- + \sigma_R^-$  is odd,  
then a period-2 orbit exists after border collision.



**Q5: How to apply this knowledge?**

The conditions for the occurrence of such bifurcations are now available in terms of the Jacobian matrices at the two sides of the borderline.

In practical systems, if such phenomena are observed,

- obtain the eigenvalues before and after a border collision,
- obtain the trace and the determinant, and
- match with the available theory.

- Prediction of bifurcation
- Control of bifurcation.

- Controlling the position of the borderline
- Controlling the Jacobian at the two sides of the borderline

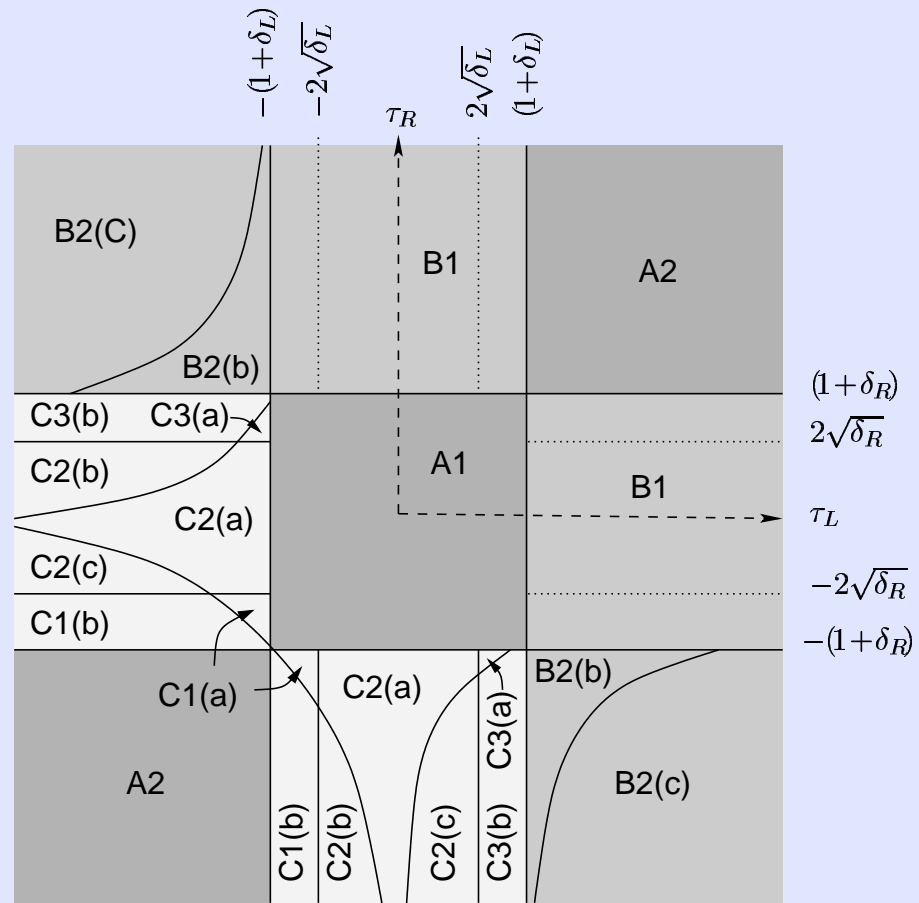

**Thank You**